

# Duo petra

4871

AM  
STUDIO  
CUSTOM LIGHTING

VIBIA



Design By Ramos & Bassols

Duo Petra is a surface installation ceiling light where its interior natural slate appearance is combined with the technical elegance of its aluminum outer shell.

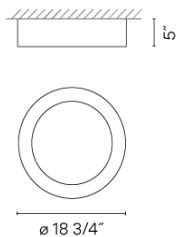
## Spec sheet



Any modifications require a minimum order quantity and extra lead time

<b>Finish</b>	 18 Graphite ADAPTA RF 9913
	 93 White RAL 9016
	 58 Cream RAL 7044
<b>LED</b>	2700 K / 3500 K / Tunable White
<b>Dimming</b>	DALI / 0-10V
<b>Installation type</b>	Surface

<b>LED</b>	CRI>90 2206 lm 98 2700 K / 3500 K / Tunable White
<b>Driver</b>	Constant Current 500 120-277 V V 50-60 Hz HZ 
<b>Application</b>	Ceiling Fixtures
<b>Packaging</b>	1 Box 21.97 m x 21.97 m x 10.04 m Gross weight 15.42 Net weight 13.22 Vol. 2.8005

### Lighting effect

#### General

First layer of basic, general illumination

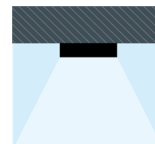

### Photometric Data

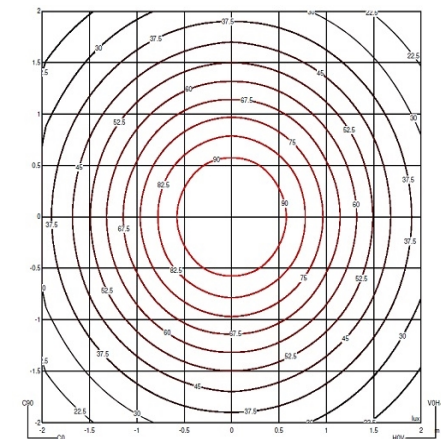
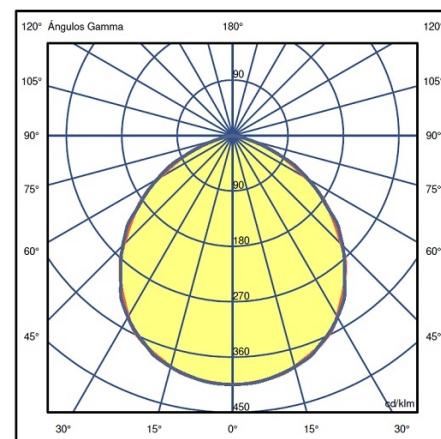

<b>Efficiency</b>	69,505 lm/W
<b>Coordination System</b>	CG
<b>Total Flux</b>	1796.0 lm
<b>Maximum Value</b>	404.43 cd/klm

All of our products come with a two year standard warranty. Check US & Canada Term and Condition sales@vibia.com

VIBIA, INC.

Office / Oficina  
272 Fernwood Ave. Edison, NJ 08837. USA

International T 732 417 1700  
Spain / Portugal T +34 934 796 970

sales@vibia.com  
www.vibia.com/us/usa

# Duo petra

4873

VIBIA

Design By Ramos & Bassols

Duo Petra is a surface installation ceiling light where the natural appearance of slate on the inside is combined with the technical elegance of the aluminum casing on the outside. Its large dimensions and diffused lighting help illuminate large spaces with a single electrical connection.

## Spec sheet

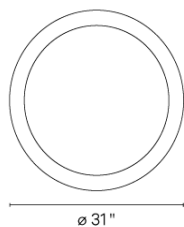
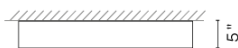

Any modifications require a minimum order quantity and extra lead time

### Finish

58 Cream  
RAL 7044

93 White  
RAL 9016

18 Graphite  
ADAPTA RF 9913

### LED

2700 K / 3500 K / Tunable White

### Dimming

DALI / 0-10V

### Installation type

Surface

### LED

CRI>90 3958.8 lm 98  
2700 K / 3500 K / Tunable White

### Driver

Constant Current 700 120~277 V V  
50~60 Hz HZ

LED IP20 Multi-volt 50-60Hz

### Application

Ceiling Fixtures

### Packaging

1 Box  
35.28 m x 34.72 m x 9.8 m  
Gross weight 41.85  
Net weight 37.44  
Vol. 6.9465

### Lighting effect

#### General

First layer of basic, general illumination

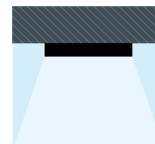

#### Photometric Data

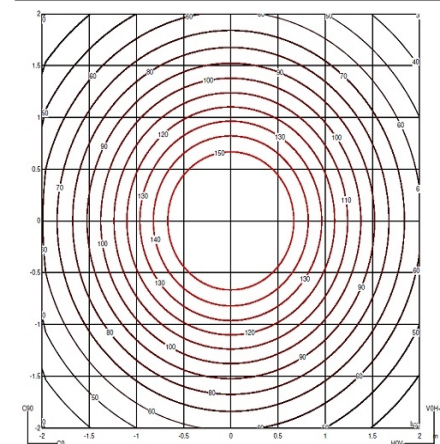
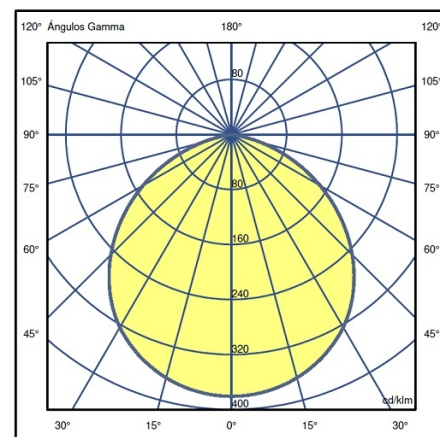

Efficiency 77.317 lm/W  
Coordination System CG  
Total Flux 3580.0 lm  
Maximum Value 380.69 cd/klm

All of our products come with a two year standard warranty. Check US & Canada Term and Condition sales@vibia.com

VIBIA, INC.

Office / Oficina

272 Fernwood Ave. Edison, NJ 08837. USA

International T 732 417 1700

Spain / Portugal T +34 934 796 970

sales@vibia.com

www.vibia.com/us/usa

# Duo petra

4879



Design By Ramos & Bassols

# VIBIA

Duo Petra is a surface installed ceiling light where the interior features the natural appearance of slate. The Duo Petra ceiling light becomes a focal point without needing to be suspended.

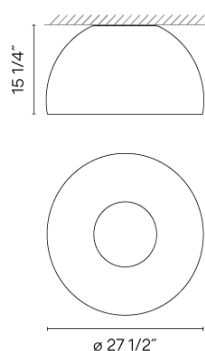
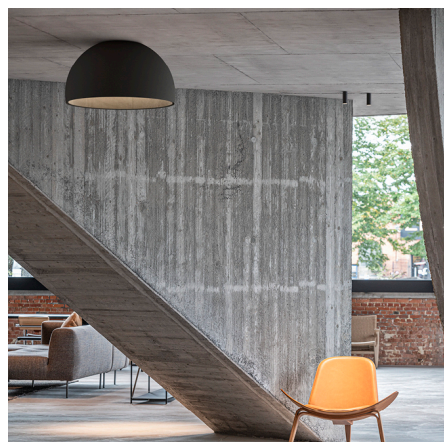
## Spec sheet

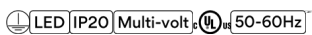

<b>Finish</b>	 58 Cream RAL 7044
	 18 Graphite ADAPTA RF 9913
	 93 White RAL 9016
<b>LED</b>	2700 K / 3500 K / Tunable White
<b>Dimming</b>	0-10V / DALI
<b>Installation type</b>	Surface

<b>LED</b>	CRI>90 2206 lm 98 2700 K / 3500 K / Tunable White
<b>Driver</b>	Constant Current 500 120-277 V V 50-60 Hz HZ 
<b>Application</b>	Ceiling Fixtures
<b>Packaging</b>	1 Box 23.35 m x 30.91 m x 30.91 m Gross weight 35.24 Net weight 30.84 Vol. 12.9041

### Lighting effect

#### General

First layer of basic, general illumination

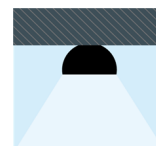

### Photometric Data

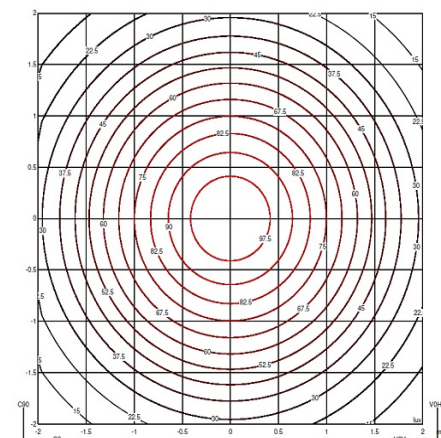
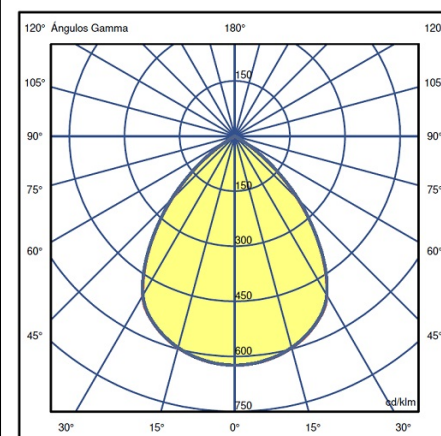

<b>Efficiency</b>	46.739 lm/W
<b>Coordination System</b>	CG
<b>Total Flux</b>	1201.8 lm
<b>Maximum Value</b>	623.60 cd/klm

Any modifications require a minimum order quantity and extra lead time

All of our products come with a two year standard warranty. Check US & Canada Term and Condition sales@vibia.com

VIBIA, INC.

Office / Oficina  
272 Fernwood Ave. Edison, NJ 08837. USA

International T 732 417 1700  
Spain / Portugal T +34 934 796 970

sales@vibia.com  
www.vibia.com/us/usa

# Duo petra

4881

Design By Ramos & Bassols

# VIBIA

Duo Petra is a surface installed ceiling light where the interior features the natural appearance of slate. The angled ceiling model is perfect for directing its diffuse lighting towards the required location

## Spec sheet

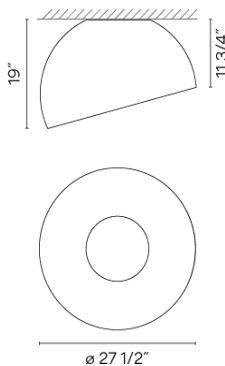

Any modifications require a minimum order quantity and extra lead time

### Finish

18 Graphite  
ADAPTA RF 9913

58 Cream  
RAL 7044

93 White  
RAL 9016

### LED

2700 K / 3500 K / Tunable White

### Dimming

DALI / 0-10V

### Installation type

Surface

### LED

CRI>90 2068 lm 109  
2700 K / 3500 K / Tunable White

### Driver

Constant Current 500 120-277 V V  
50-60 Hz HZ

LED IP20 Multi-volt 50-60Hz

### Application

Ceiling Fixtures

### Packaging

1 Box  
23.35 m x 30.91 m x 30.91 m  
Gross weight 35.24  
Net weight 30.84  
Vol. 12.9041

### Lighting effect

#### General

First layer of basic, general illumination

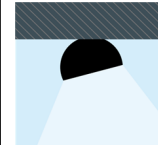

### Photometric Data

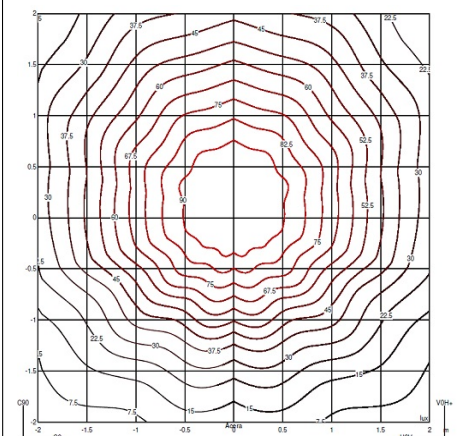
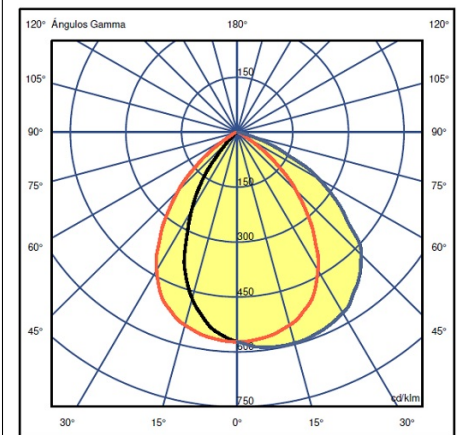

Efficiency 50.193 lm/W  
Coordination System CG  
Total Flux 1313.6 lm  
Maximum Value 596.17 cd/klm

All of our products come with a two year standard warranty. Check US & Canada Term and Condition sales@vibia.com

VIBIA, INC.

Office / Oficina  
272 Fernwood Ave. Edison, NJ 08837. USA

International T 732 417 1700  
Spain / Portugal T +34 934 796 970

sales@vibia.com  
www.vibia.com/us/usa